

Formulate Straight Fabric Display

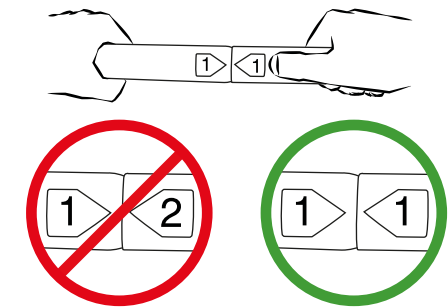

1

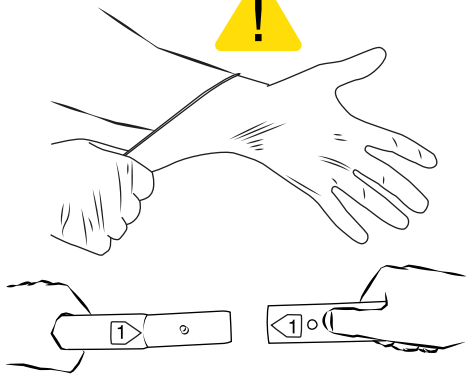
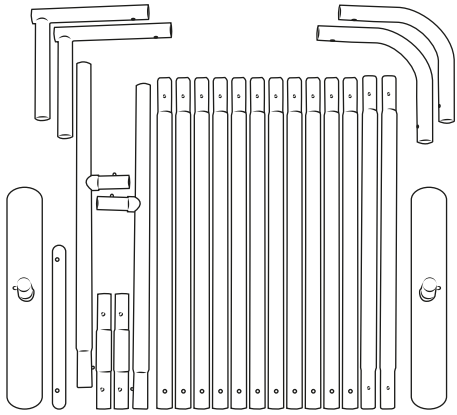
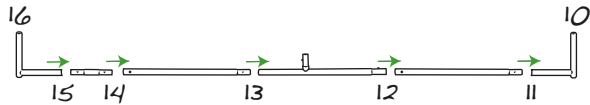

3

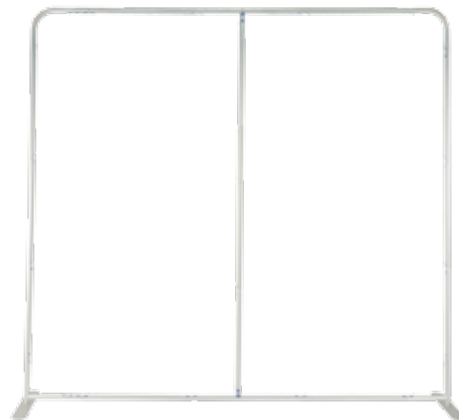
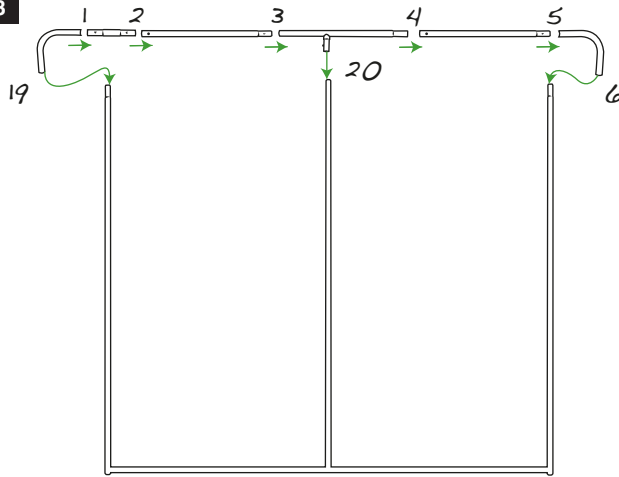

2

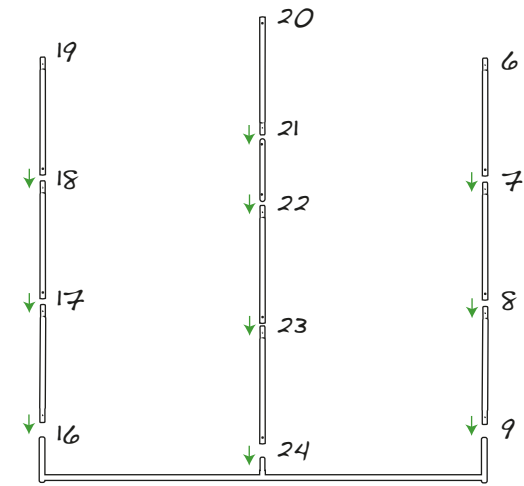

4

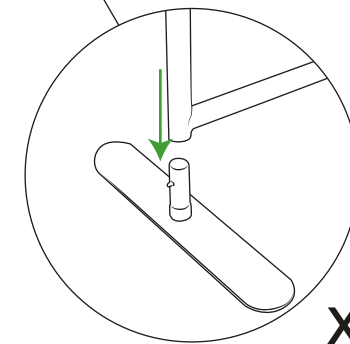
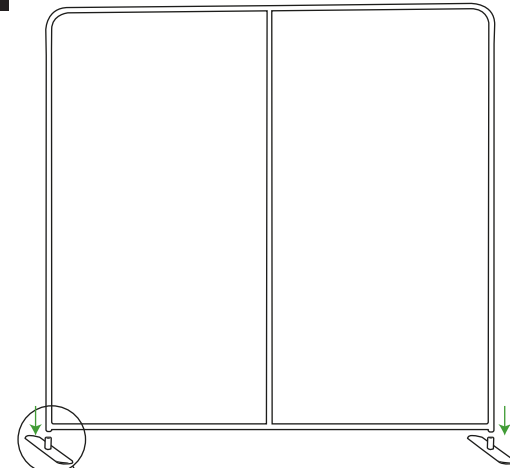

x2

FORMULATE

Fabric Displays
Counters
Retail Displays
Exhibition & Hanging Displays

Important note: These instructions are based on assembling the 2.4m version. Other size kits will have slightly different configurations of poles but can still be assembled in the same way.



Attaching Graphic

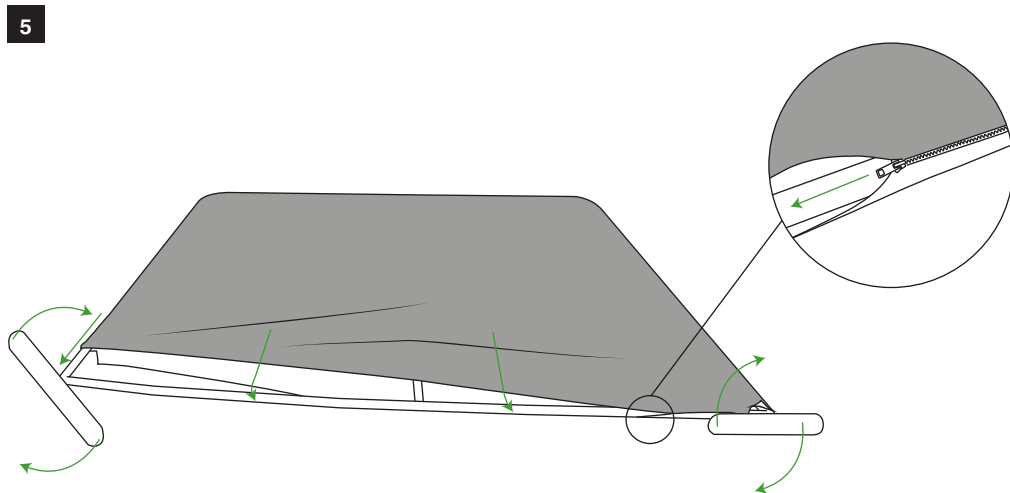
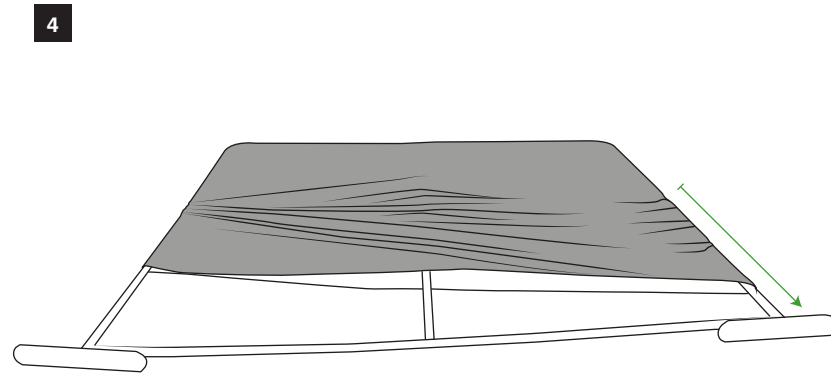
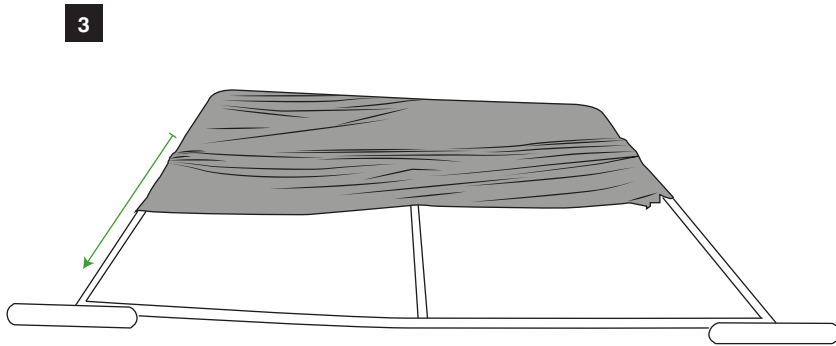
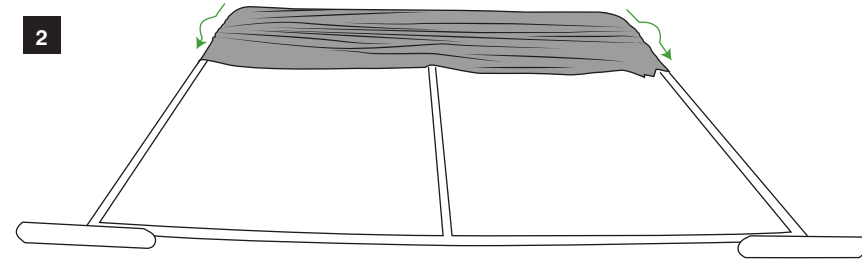
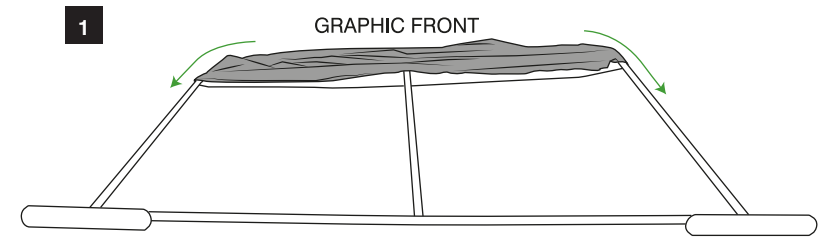

FORMULATE

Fabric Displays
Counters
Retail Displays
Exhibition &
Hanging Displays